

DJ MIXER

DJM-500

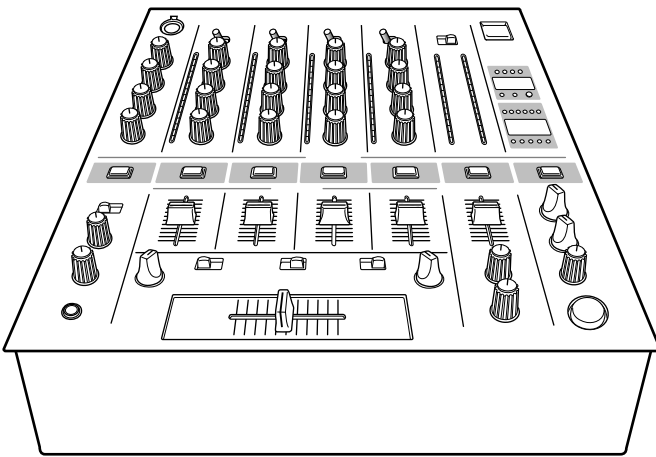

Thank you for buying this Pioneer product.
Please read through these operating instructions so you will know how to operate your model properly.
After you have finished reading the instructions, put them away in a safe place for future reference.

WARNING: TO PREVENT FIRE OR SHOCK HAZARD, DO NOT EXPOSE THIS APPLIANCE TO RAIN OR MOISTURE.

CAUTION: This product satisfies FCC regulations when shielded cables and connectors are used to connect the unit to other equipment. To prevent electromagnetic interference with electric appliances such as radios and televisions, use shielded cables and connectors for connections.

CONTENTS

CAUTIONS REGARDING HANDLING	4
Location	4
Condensation	4
Cleaning the unit	4
CHECKING ACCESSORIES	4
FEATURES	5
CONNECTIONS	6
1. Connection of Input Equipment	6
2. Connection of Outputs, Microphones, Etc.	7
NAME AND FUNCTION OF PARTS	8
Front section	8
Rear section	11
USING THE EFFECT FUNCTION	12
Features of Various Effectors	12
Measuring BPM	14
Operating Delay, Echo, Auto pan, Flanger	15
Operating Pitch Shifter and Reverb	16
Using the External Effector	16
USING THE FADER START FUNCTION	17
Starting the Cross Fader	17
Starting the Channel fader	17
TROUBLESHOOTING	18
SPECIFICATIONS	19

IMPORTANT NOTICE:

RECORD THE MODEL NUMBER AND SERIAL NUMBER OF THIS EQUIPMENT BELOW. THE NUMBERS ARE ON THE REAR PANEL.

MODEL NO. DJM-500
SERIAL NO.

KEEP THESE NUMBERS FOR FUTURE USE.

IMPORTANT



The lightning flash with arrowhead, within an equilateral triangle, is intended to alert the user to the presence of uninsulated "dangerous voltage" within the product's enclosure that may be of sufficient magnitude to constitute a risk of electric shock to persons.

CAUTION

RISK OF ELECTRIC SHOCK
DO NOT OPEN

CAUTION:
TO PREVENT THE RISK OF ELECTRIC SHOCK, DO NOT REMOVE COVER (OR BACK). NO USER-SERVICEABLE PARTS INSIDE. REFER SERVICING TO QUALIFIED SERVICE PERSONNEL.



The exclamation point within an equilateral triangle is intended to alert the user to the presence of important operating and maintenance (servicing) instructions in the literature accompanying the appliance.

SAFETY INSTRUCTIONS

READ INSTRUCTIONS – All the safety and operating instructions should be read before the appliance is operated.

RETAIN INSTRUCTIONS – The safety and operating instructions should be retained for future reference.

HEED WARNING – All warnings on the appliance and in the operating instructions should be adhered to.

FOLLOW INSTRUCTIONS – All operating and use instructions should be followed.

WATER AND MOISTURE – The appliance should not be used near water – for example, near a bathtub, washbowl, kitchen sink, laundry tub, in a wet basement, or near a swimming pool, etc.

LOCATION – The appliance should be installed in a stable location.

WALL OR CEILING MOUNTING – The appliance should not be mounted to a wall or ceiling.

VENTILATION – The appliance should be situated so that its location or position does not interfere with its proper ventilation. For example, the appliance should not be situated on a bed, sofa, rug, or similar surface that may block the ventilation openings; or, placed in a built-in installation, such as a bookcase or cabinet that may impede the flow of air through the ventilation openings.

HEAT – The appliance should be situated away from heat sources such as radiators, heat registers, stoves, or other appliances (including amplifiers) that produce heat.

POWER SOURCES – The appliance should be connected to a power supply only of the type described in the operating instructions or as marked on the appliance.

POWER-CORD PROTECTION – Power-supply cords should be routed so that they are not likely to be walked on or pinched by items placed upon or against them. Pay particular attention to cords at plugs, convenience receptacles, and the point where they exit from the appliance.

GROUNDING-TYPE PLUG – This product is equipped with a three-wire grounding-type plug, a plug having a third (grounding) pin. This plug will only fit into a grounding-type power outlet. This is a safety feature. If you are unable to insert the plug into the outlet, contact your electrician to replace your obsolete outlet. Do not defeat the safety purpose of the grounding-type plug.

CLEANING – The appliance should be cleaned only with a polishing cloth or a soft dry cloth. Never clean with furniture wax, benzene, insecticides or other volatile liquids since they may corrode the cabinet.

POWER LINES – An outdoor antenna should be located away from power lines.

NONUSE PERIODS – The power cord of the appliance should be unplugged from the outlet when left unused for a long period of time.

OBJECT AND LIQUID ENTRY – Care should be taken so that objects do not fall and liquids are not spilled into the enclosure through openings.

DAMAGE REQUIRING SERVICE – The appliance should be serviced by a Pioneer authorized service center or qualified service personnel when:

- The power-supply cord or the plug has been damaged.
- Objects have fallen, or liquid has been spilled into the appliance.
- The appliance has been exposed to rain.
- The appliance does not appear to operate normally or exhibits a marked change in performance.
- The appliance has been dropped or the enclosure damaged.

SERVICING – The user should not attempt to service the appliance beyond that described in the operating instructions. All other servicing should be referred to qualified service personnel.

OUTDOOR ANTENNA GROUNDING – If an outside antenna is connected to the antenna terminal, be sure the antenna system is grounded so as to provide some protection against voltage surges and built-up static charges.

In the U.S.A. section 810 of the National Electrical Code, ANSI/NFPA 70, provides information with respect to proper grounding of the mast and supporting structure, grounding of the lead-in wire to an antenna discharge unit, size of grounding conductors, location of antenna discharge unit, connection to grounding electrodes, and requirements for the grounding electrode. See Fig. A.

CART – An appliance and cart combination should be moved with care. Quick stops, excessive force, and uneven surfaces may cause the appliance and cart combination to overturn.



NEC – NATIONAL ELECTRIC CODE

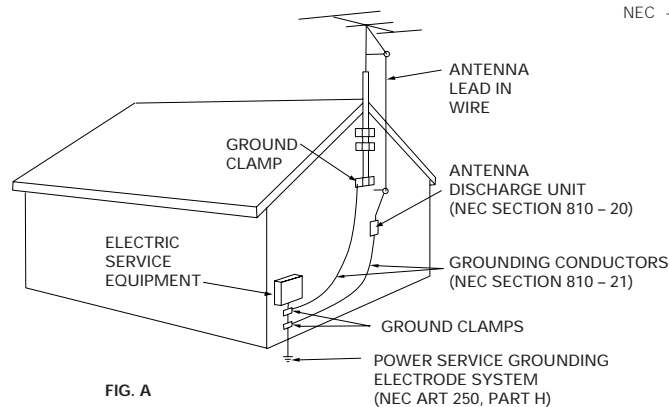

FIG. A

[For Canadian model]

This Class B digital apparatus meets all requirements of the Canadian Interference-Causing Equipment Regulations.

[Pour le modèle Canadien]

Cet appareil numérique de la Classe B respecte toutes les exigences du Règlement sur le matériel brouilleur du Canada.

Information to User

Alteration or modifications carried out without appropriate authorization may invalidate the user's right to operate the equipment.

This equipment has been tested and found to comply with the limits for a Class B digital device, pursuant to Part 15 of the FCC Rules. These limits are designed to provide reasonable protection against harmful interference in a residential installation. This equipment generates, uses, and can radiate radio frequency energy and, if not installed and used in accordance with the instructions, may cause harmful interference to radio communications. However, there is no guarantee that interference will not occur in a particular installation. If this equipment does cause harmful interference to radio or television reception, which can be determined by turning the equipment off and on, the user is encouraged to try to correct the interference by one or more of the following measures:

- Reorient or relocate the receiving antenna.
- Increase the separation between the equipment and receiver.
- Connect the equipment into an outlet on a circuit different from that to which the receiver is connected.
- Consult the dealer or an experienced radio/TV technician for help.



Dear Customer:

Selecting fine audio equipment such as the unit you've just purchased is only the start of your musical enjoyment. Now it's time to consider how you can maximize the fun and excitement your equipment offers. This manufacturer and the Electronic Industries Association's Consumer Electronics Group want you to get the most out of your equipment by playing it at a safe level. One that lets the sound come through loud and clear without annoying blaring or distortion-and, most importantly, without affecting your sensitive hearing.

Sound can be deceiving. Over time your hearing "comfort level" adapts to higher volumes of sound. So what sounds "normal" can actually be loud and harmful to your hearing. Guard against this by setting your equipment at a safe level BEFORE your hearing adapts.

To establish a safe level:

- Start your volume control at a low setting.
- Slowly increase the sound until you can hear it comfortably and clearly, and without distortion.

Once you have established a comfortable sound level:

- Set the dial and leave it there.

Taking a minute to do this now will help to prevent hearing damage or loss in the future. After all, we want you listening for a lifetime.

We Want You Listening For A Lifetime

Used wisely, your new sound equipment will provide a lifetime of fun and enjoyment. Since hearing damage from loud noise is often undetectable until it is too late, this manufacturer and the Electronic Industries Association's Consumer Electronics Group recommend you avoid prolonged exposure to excessive noise. This list of sound levels is included for your protection.

Decibel

<u>Level</u>	<u>Example</u>
30	Quiet library, soft whispers
40	Living room, refrigerator, bedroom away from traffic
50	Light traffic, normal conversation, quiet office
60	Air conditioner at 20 feet, sewing machine
70	Vacuum cleaner, hair dryer, noisy restaurant
80	Average city traffic, garbage disposals, alarm clock at two feet.

THE FOLLOWING NOISES CAN BE DANGEROUS UNDER CONSTANT EXPOSURE

90	Subway, motorcycle, truck traffic, lawn mower
100	Garbage truck, chain saw, pneumatic drill
120	Rock band concert in front of speakers, thunderclap
140	Gunshot blast, jet plane
180	Rocket launching pad

Information courtesy of the Deafness Research Foundation.



CAUTIONS REGARDING HANDLING

Location

Install the unit in a well-ventilated location where it will not be exposed to high temperatures or humidity.

Do not install the unit in a location which is exposed to direct rays of the sun, or near stoves or radiators. Excessive heat can adversely affect the cabinet and internal components. Installation of the unit in a damp or dusty environment may also result in a malfunction or accident. (Avoid installation near cookers etc., where the unit may be exposed to oily smoke, steam or heat.)

Condensation

When this unit is brought into a warm room from previously cold surroundings or when the room temperature rises sharply, condensation may form inside, and the unit may not be able to attain its full performance. In cases like this, allow the unit to stand for about an hour or raise the room temperature gradually.

Cleaning the unit

- Use a polishing cloth to wipe off dust and dirt.
- When the surfaces are very dirty, wipe with a soft cloth dipped in some neutral cleanser diluted five or six times with water and wrung out well, then wipe again with a dry cloth. Do not use furniture wax or cleaners.
- Never use thinners, benzene, insecticide sprays or other chemicals on or near this unit, since these will corrode the surfaces.

CHECKING ACCESSORIES

- Power cord

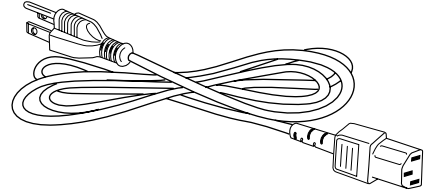

- Short-circuit pin plug (four)
These are inserted in the PHONO 1 and PHONO 2 terminals at the rear.
- Operating instructions

FEATURES

BPM Counter

The auto BPM counter provided allows the tempo of songs to be checked visually. This counter can be switched between real-time and average.

BPM Level Display (Beat meter display)

Displays the level of sound components determining the BPM.

The beat can be checked visually.

Peak Level Meter

The peak level meter provided is equipped with 15-bit LED indicators for all channels. This meter can be switched between BPM and peak.

Fader Start

The CD player can be started by increasing the level of the cross fader or channel fader, which is selected using the cross fader switch. (This function can be used only when the Pioneer CD player CDJ-500 series is connected.)

3-Band Equalizer & Kill

A 3-band equalizer corresponding to the HI, MID, and LOW channels. The attenuation level also serves as a kill function which can decrease the level to -20 dB.

Digital Display of Effector

Loads the master tempo incorporated in Pioneer CD players. Key changes by the rotary type linear control can give new performance effects to the mixer.

Variety of Effects

Both external effects and internal effects can be imposed on all channels, the microphone, and master.

A variety of effects such as delay, echo, auto pan, flanger, reverb, and pitch shifter can be enjoyed.

Enhanced Input/Output Terminals

In addition to the 9 inputs, 2 CD and 2 LINE systems, 3 PHONO (for MM only) systems, and 2 microphone systems, three outputs including the pro-specifications XLR output, and booth monitor output are provided independently.

SEND/RETURN terminals are also provided for the external effectors.

CONNECTIONS

When connecting the units or changing their connections, be sure to turn off the power switch and disconnect the power cord from the outlet.

1. Connection of Input Equipment

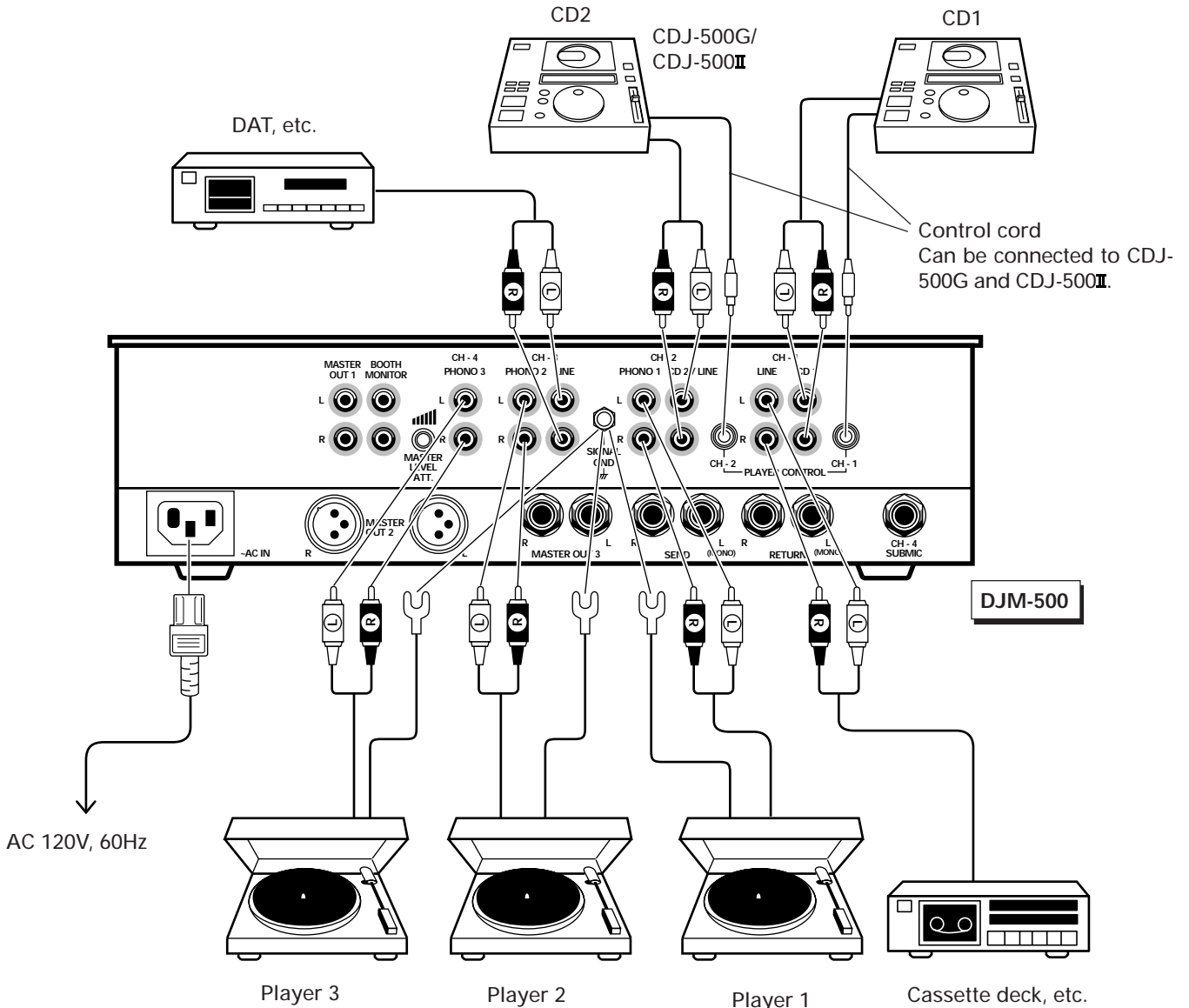

To connect the analog player, remove the short-circuit pin plugs (four) inserted in the PHONO terminals (PHONO 1, PHONO 2) of CH2 and CH3. These short-circuit pin plugs serve to cut fine noises to provide high performance when not connecting the analog player. Be sure to keep them carefully after removal. When removed for connecting the analog player, insert them back as before after use.

Connecting audio cords

Use cords with red and white pin plugs. Connect the white plug to (L) and the red plug to (R). Be sure to insert completely.

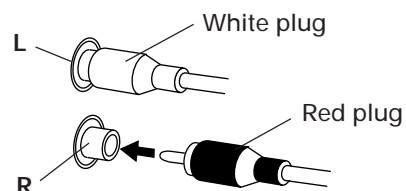

2. Connection of Outputs, Microphones, Etc.

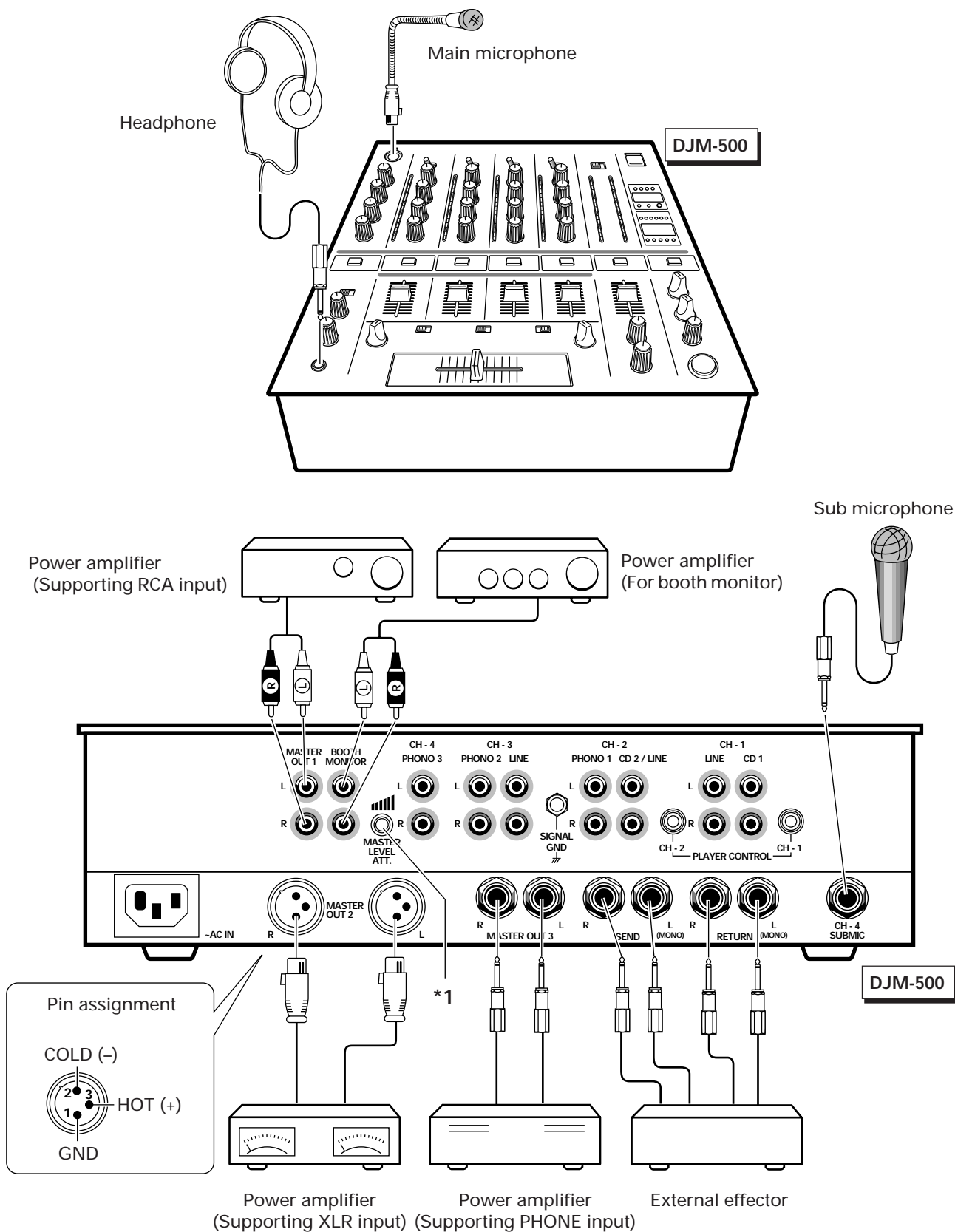

*1 Master level attenuator knob

To protect the connected amplifiers and speakers from excessive inputs, this knob is used to decrease the output level.

NAME AND FUNCTION OF PARTS

Front section

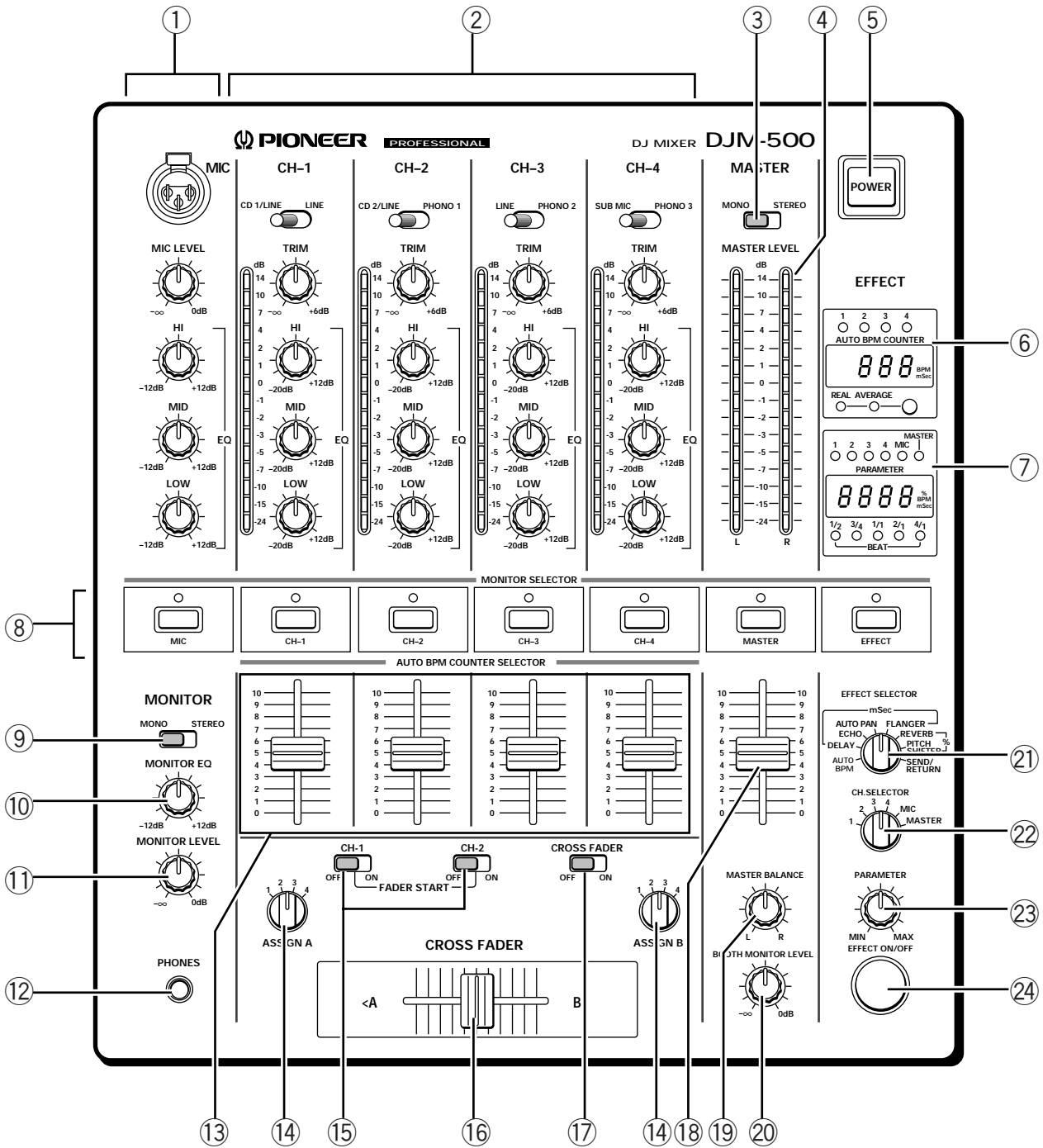

① **Main Microphone Terminal and Microphone Control Knob**

MIC Level:

Used for adjusting the volume of the main microphone. (Attenuated level $-\infty$ to 0 dB)

HI:

Used for adjusting the high tone of the microphone sound.

Flat at center click.

Increases when rotated to the right. (To +12 dB at 10 kHz)

Decreases when rotated to the left. (To -12 dB at 10 kHz)

MID:

Used for adjusting the middle tone of the microphone sound.

Flat at center click.

Increases when rotated to the right. (To +12 dB at 1 kHz)

Decreases when rotated to the left. (To -12 dB at 1 kHz)

LOW:

Used for adjusting the low tone of the microphone sound.

Flat at center click.

Increases when rotated to the right. (To +12 dB at 100 Hz)

Decreases when rotated to the left. (To -12 dB at 100 Hz)

② **CH1 to CH4 Input Selection Switch and Control Knob/Peak level meter**

Input selection switch:

Selects which sound of the two units connected to each CH to use.

CH1 : Switches between CD1/LINE and LINE

CH2 : Switches between CD2/LINE and PHONO 1

CH3 : Switches between LINE and PHONO 2

CH4 : Switches between SUB MIC and PHONO 3

TRIM:

Used for adjusting the level of the input signal.

The level increases when rotated to the right. (To +6 dB)

The level decreases when rotated to the left. (To $-\infty$)

HI:

Used for adjusting the high tone.

Flat at center click.

Increases when rotated to the right. (To +12 dB at 10 kHz)

Decreases when rotated to the left. (To -20 dB at 10 kHz)

MID:

Used for adjusting the middle tone.

Flat at center click.

Increases when rotated to the right. (To +12 dB at 1 kHz)

Decreases when rotated to the left. (To -20 dB at 1 kHz)

LOW:

Used for adjusting the low tone.

Flat at center click.

Increases when rotated to the right. (To +12 dB at 100 Hz)

Decreases when rotated to the left. (To -20 dB at 100 Hz)

Peak level meter:

Displays the peak level holding it for two seconds.

Displays the level before channel fader.

The display range is about -24 dB to +14 dB.

When BPM is selected using the effect selector and the effect switch is turned on, the beat monitor function will be turned on.

③ **Master Output Monaural/Stereo Selection Switch (MONO/STEREO)**

④ **Master level meter (MASTER LEVEL)**

Displays the output level after master volume adjustment while holding it for 2 seconds.

The display range is -24 dB to +14 dB.

⑤ **Power Supply Switch (POWER)**

⑥ **BPM Display (Refer to Page 14.)**

- When BPM is selected using the effect selector, the BPM of the source selected with the monitor selector (CH1 to CH4) will be displayed.

1 to 4:

Displays the channel measuring the BPM.

Counter:

Displays the BPM value.

Real-time/average selection button and indicator: (When REAL is selected.)

The counter displays the measured BPM value.

It will be displayed blinking. If it could not be measured for more than 5 seconds, "-- --" is displayed.

(When AVERAGE is selected.)

The display changes when it could be measured.

While measuring, the previous value will remain displayed.

- When other than BPM is selected using the effect selector (DELAY, ECHO, AUTO PAN, FLANGER), the source BPM selected using the effect channel selector (②) is converted to hours and displayed on the counter.

⑦ **Effector Parameter/BPM Display (Refer to Page 14.)**

1 to 4 MIC MASTER:

Displays the effect source.

Counter:

Displays the effect source BPM and effect parameter, etc. (Refer to ③ for details of the parameter.)

BPM...375 to 857 mSec (1 mSec step)

70.0 to 160.0 BPM (0.1 BPM step)

BEAT:

When the effect is set to delay, echo, auto pan, or flanger, displays to which beat the parameter is set. (1/2 to 4 beats)

⑧ **Monitor Selector/Auto BPM Counter Selector button (MONITOR SELECTOR/AUTO BPM COUNTER SELECTOR)**

- Selects the source which is monitored using the headphone (CH1 to 4, MIC, MASTER, EFFECT). When several buttons are pressed, sounds can be mixed. When the button is pressed another time, the selection is canceled.
- When BPM is selected using the effect selector, the channel displaying the BPM (CH1 to CH4) is selected. When more than two are selected together, BPM will not be displayed properly.

NAME AND FUNCTION OF PARTS

- ⑨ **Monitor Monaural/Stereo Selector Switch (MONO/STEREO)**
- ⑩ **Monitor Equalizer Knob (MONITOR EQ)**
Used to obtain the beat easily with the headphone monitor sound.
Increases/decreases low tone.
Flat at center click.
Increases when rotated to the right. (To +12 dB at 100 Hz)
Decreases when rotated to the left. (To -12 dB at 100 Hz)
- ⑪ **Monitor Level Knob (MONITOR LEVEL)**
Used for adjusting the headphone monitor volume.
Not affected by the master volume and master balance.
- ⑫ **Headphone Terminal (PHONES)**
- ⑬ **Channel Fader Volume**
Used for adjusting the volume of CH1 to CH4.
- ⑭ **Assign Switch (ASSIGN A, B)**
When performing cross fader using two sources (A, B), select the channels (CH1 to CH4) to be assigned to A and B.
Effective when the cross fader switch (⑰) is on (cross fader mix).
- ⑮ **Fader Start Switch (FADER START) (Refer to Page 17.)**
When the optional CD player (CDJ-500G or CDJ-500II) is connected to the unit using the control cord, this ON/OFF switch is used to start automatic playing of the CD player using the channel fader or cross fader.
- ⑯ **Cross Fader Volume (CROSS FADER)**
Adjusts the mix volume of the sources set to A and B using the assign switch (⑭).
- ⑰ **Cross Fader Switch (CROSS FADER ON/OFF)**
OFF:
Select when mixing sounds using the channel fader volume. (Direct mix.)
ON:
Select when mixing sounds using the cross fader. (Cross fader mix.)
- ⑱ **Master Volume Level Adjustment**
Used to adjust the level of the master output volume.
When the cross fader is ON, the sounds of assigns A, B and main microphone will be output.
When the cross fader is OFF, the sounds of each channel and main microphone will be output.
- ⑲ **Master Balance Knob (MASTER BALANCE)**
Used to adjust the left and right balance of the master output.
- ⑳ **Booth Monitor Level Knob (BOOTH MONITOR LEVEL)**
Used to adjust the output level of the BOOTH MONITOR terminal.
Not affected by the master volume and master balance.
- ㉑ **Effect Selector Switch (EFFECT SELECTOR)**
AUTO BPM (Beat/minute):
Select when performing BPM detection.
DELAY:
Delays the time and repeats once.
ECHO:
Delays the time and repeats several times to produce the echo effects.
AUTO PAN:
Shifts the left and right channels periodically.
FLANGER:
Produces periodic sound change effects by mixing the short delay sound and original sound.
REVERB:
Produces the reverb effects.
PITCH SHIFTER:
Changes the pitch of the song.
SEND/RETURN:
Select when connecting and using the external effector.
- ㉒ **Effect Channel Selector (CH. SELECTOR)**
Use to select the source to be effected.
- ㉓ **Parameter Knob (PARAMETER)**
Used to adjust the parameter of the effector selected with the effect selector switch.
DELAY:
0 to 680 mSec (2 mSec step to 100, 5 mSec step from 100 to 680)
ECHO:
0 to 680 mSec (2 mSec step to 100, 5 mSec step from 100 to 680)
AUTO PAN:
0 to 3500 mSec (5 mSec to 100, 10 mSec from 100 to 900, 20 mSec step from 900 to 3500)
FLANGER:
100 to 9000 mSec (10 mSec to 900, 50 mSec from 900 to 9000)
REVERB:
0 to 100% (1% step)
PITCH SHIFTER:
0 to ±100% (1% from 0 to 10, 2% step from 10 to 100)
- ㉔ **Effect Switch (EFFECT ON/OFF)**
Use to switch the effect on/off.
When turned on according to the beat, the effects will also correspond to the beat.
When the effect is on, it goes on and off.

Rear section

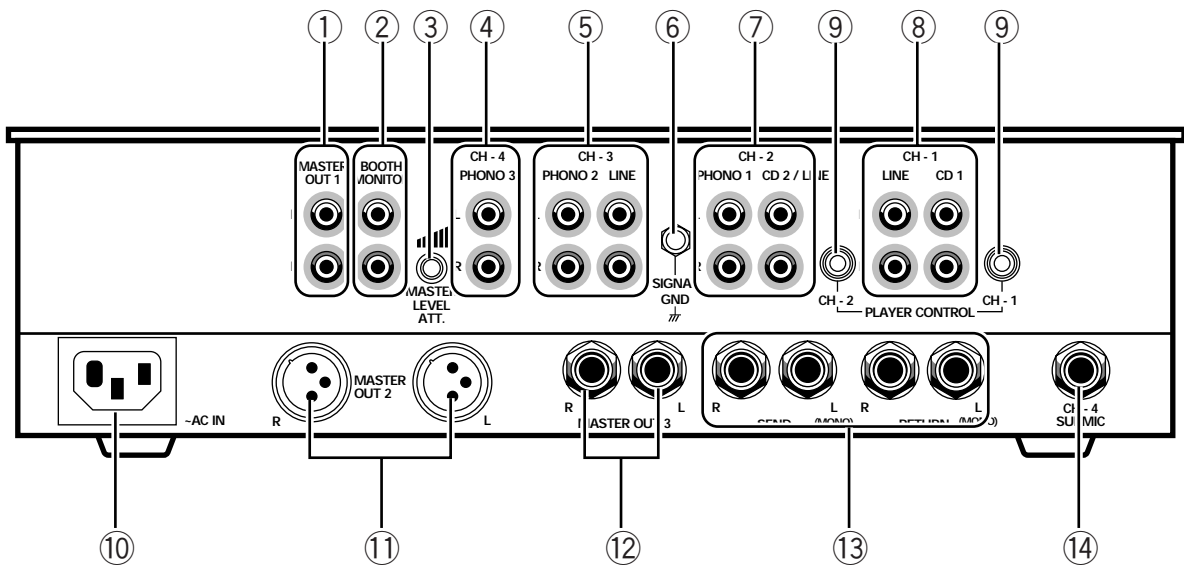

- ① **Master Output 1 Terminal (MASTER OUT 1)**
Connects the power amplifier using a cord with RCA plug.
- ② **Booth Monitor Output Terminal (BOOTH MONITOR)**
Connects the power amplifier which connects the speaker for monitoring audio.
- ③ **Master Output Level Adjustment Knob (MASTER LEVEL ATT.)**
- ④ **CH-4 Phono Input Terminal (PHONO 3)**
PHONO 3 : Connects the analog player. (for MM only)
- ⑤ **CH-3 Input Terminal**
PHONO 2 : Connects the analog player. (for MM only)
LINE : Connects audio equipment such as DAT.
- ⑥ **Ground Terminal (SIGNAL GND)**
Connects to the GND cord of the analog player.

This terminal is for only an analog player, not for a safety ground.
- ⑦ **CH-2 Input Terminal**
PHONO 1 : Connects to the analog player. (for MM only)
CD/LINE : Connects optional CD players such as CDJ-500II.
- ⑧ **CH-1 Input Terminal**
LINE : Connects audio equipment such as a cassette deck, etc.
CD : Connects optional CD players such as the CDJ-500II.
- ⑨ **CH-1, 2 Player Control Terminal**
When connecting the optional CDJ-500II or CDJ-500G to the CD terminals of CH-1 or CH-2, the fader start function can be used by connecting this terminal to the control terminal of the player.
- ⑩ **Power Cord Connection Terminal**
Connects the power cord provided.
- ⑪ **Master Output 2 Terminal (MASTER OUT 2)**
Connects the XLR input supporting power amplifier.
- ⑫ **Master Output 3 Terminal (MASTER OUT 3)**
Connects the PHONE input supporting power amplifier.
- ⑬ **External Effector Connecting Terminal (SEND, RETURN)**
Used to connect other equipment for adjusting sound.
SEND (Output) : Connects the input terminal of the external effector.
Uses L channel output for using the effector of monaural input.
The sound that L and R are mixed will be sent to the effector.
RETURN (Input) : Connects the output terminal of the external effector.
Uses L channel input for using the effector of monaural input. It will be input to both channels L and R.
- ⑭ **CH-4 Sub Microphone Input Terminal (SUB MIC)**

USING THE EFFECT FUNCTION

With the built-in DSP (digital signal processor), sound effects can be enjoyed and BPM measured.

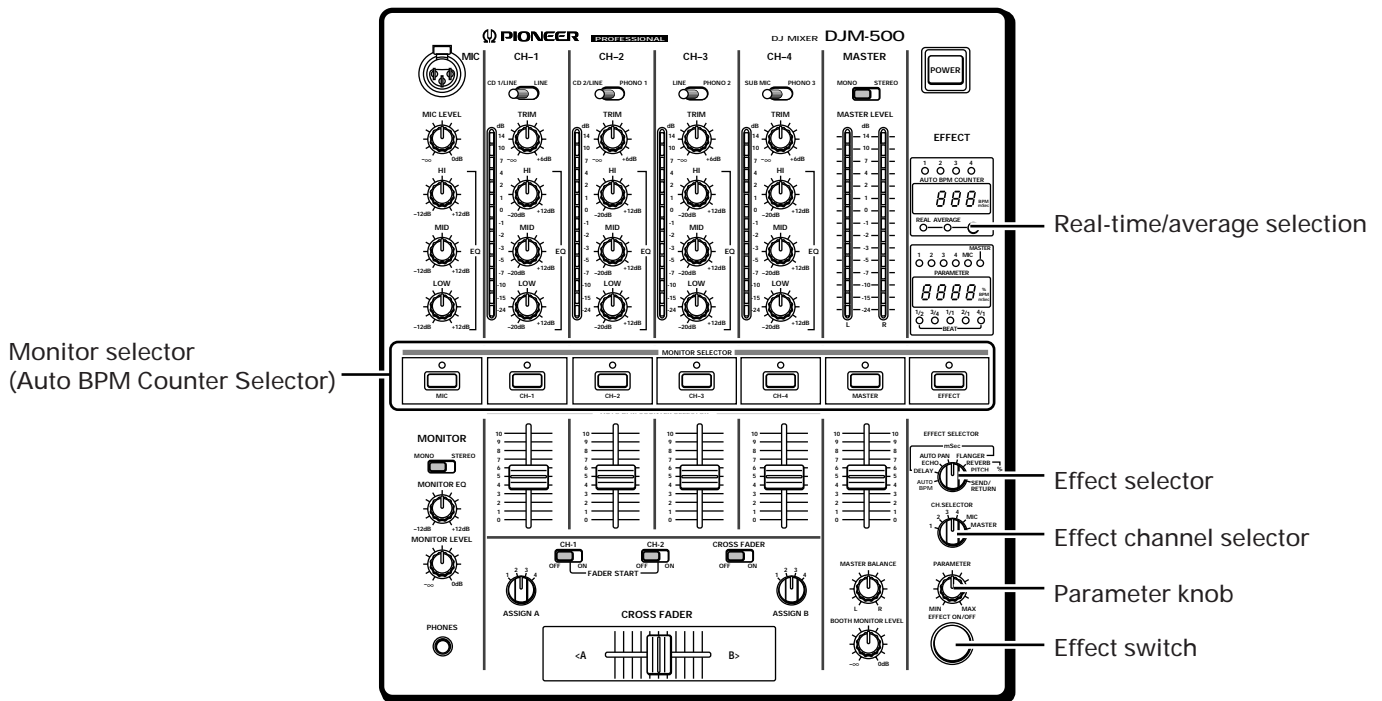

Features of Various Effectors

Auto BPM Counter (AUTO BPM COUNTER)

Automatically measures the BPM (beats per minute (tempo)) of the song and displays it digitally. (*1)

It not only counts the beat of bass sounds but also calculates, using a computer, the original BPM of the song required by DJs and displays it digitally.

This allows the BPM to now be checked not only with the ear as done previously but also visually, thereby enabling songs with different tempos to be mixed more quickly and simply.

(*1: Able to calculate the BPM of most songs, but not of some (e.g. acapella, ad lib, etc..))

Beat Effector (Effects linked to BPM)

Various effects are linked to the BPM calculated by the above auto BPM counter to allow a never-before sound mixing.

1. Delay (one repeated sound)

Mixes delay sounds of 1/2, 3/4, and 1/1 beats quickly and simply.

For example, when 1/2 beat delay sounds are mixed, the beat will change from 4 to 8.

When 3/4 beat delay sounds are mixed, the rhythm will change to a jumpy one.

(Example)

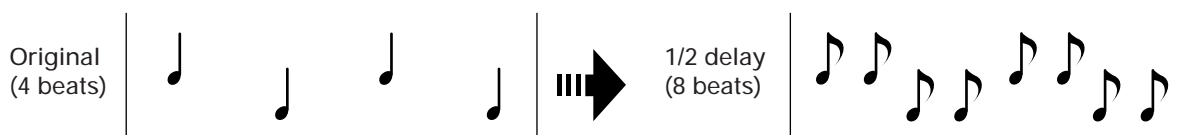

2. Echo (repeated sounds)

Mixes echo sounds of 1/2, 3/4, and 1/1 beats quickly and simply.

For example, when input sounds are cut with the 1/1 beat echo sound, the song fades out while repeating sounds corresponding to the beat.

When the microphone sound is imposed by 1/1 beat echo, it is repeatedly played back.

Troll effects can be produced by imposing 1/1 beat echo on the vocals of the song.

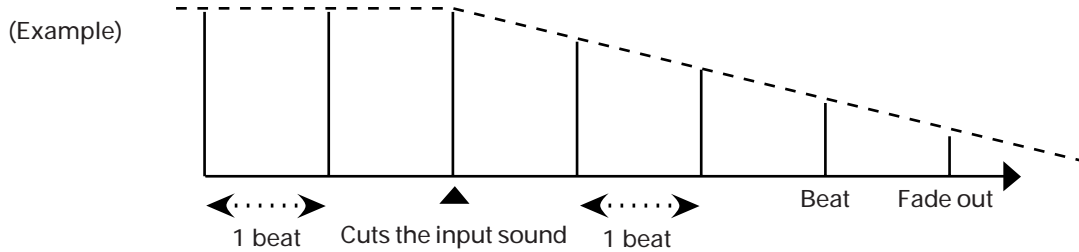

3. Auto Pan (L-R Balance)

Pans the sound to the left and right (auto beat pan) automatically according to the rhythm in beats of 1/2, 3/4, 1/1, 2/1, or 4/1.

Also pans sounds to the left and right in a short time (short auto pan) which cannot be performed manually.

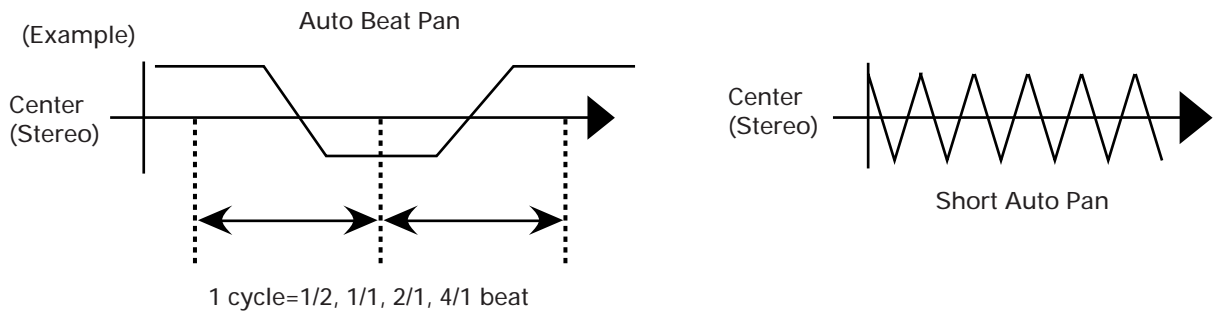

4. Flanger

Quickly and easily produces 1 cycle flanger effects in beats 1/2, 3/4, 1/1, 2/1, or 4/1.

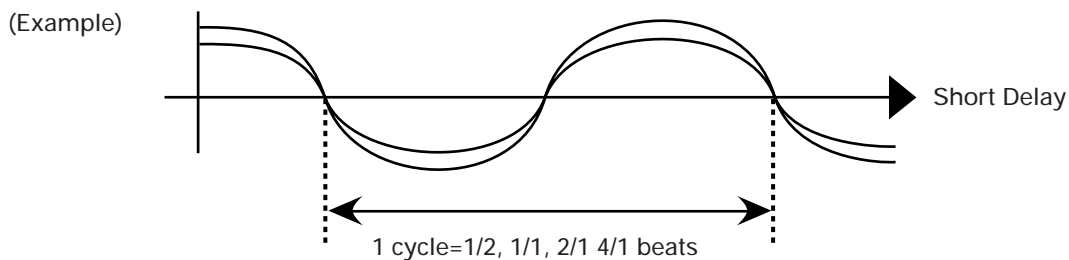

5. Pitch Shifter

The pitch (key) can be changed within the ±1 octave range.

As the speed of the analog record turntable and the CD player change by %, the changes in the volume can be corrected by %.

When the pitch shifter is set to microphone sound, it produces voice changer effects.

6. Reverb

Produces reverb effects.

7. Send/Return (External Effects Input/output)

Connects available effectors, samplers, etc.

USING THE EFFECT FUNCTION

Measuring BPM

Songs with different tempos can be mixed easily because the BPM of the channel selected using the monitor selector (auto BPM counter selector) and channel selected using the effect channel selector is measured and displayed.

(Example)

Displays the BPM of the song input to the monitor selector CH2 and effect channel selector CH4.

- 1 **Set the effect selector to AUTO BPM.**
- 2 **Set the effect channel selector to CH4.**
 - The parameter LED 4 lights up.
 - The parameter window (lower window) shows the BPM (value) of the song input to CH4.
 - * To switch the channel level meter to the beat meter, press the effect switch. Each press will switch to the channel level meter or beat meter.
 - * The BPM of some songs cannot be measured by the auto BPM counter in some cases. Even in such cases, to know the BPM, press the effect switch according to the beat of the song. After several presses, the parameter window (lower window) will show the BPM (value).
- 3 **Press CH2 of the monitor selector (auto BPM counter selector).**
 - The auto BPM counter LED 2 lights up.
 - The BPM (value) of the song input to CH2 will be displayed on the auto BPM counter window (upper window).
 - * To measure the BPM accurately, select only one from CH1 to CH4 for the auto BPM counter selector.
- 4 **Select the BPM display (real-time/average) with the switch button.**
 - Each press will switch to real-time or average display.
 - **Real-time display** : Displays the measured BPM value for every beat. If it cannot be measured for more than 5 seconds, " - - - " will be displayed.
 - **Average display** : Measures and displays the average of the BPM values measured every beat. Continues displaying the previous BPM value when the average value could not be measured.

When the player speed is adjusted and the BPM value of two channels match (within ± 1), the beat display 1/1 LED lights up. (*1)

* The parameter knob does not operate in BPM measuring mode.

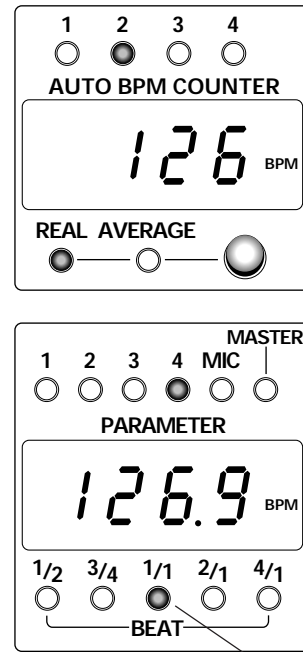

Display when BPM of CH2 (126) and BPM of CH4 (126.9) match.

Operating Delay, Echo, Auto pan, Flanger

(Example) Impose the delay effects on the CH2 song.

1 Set the effect selector to DELAY.

2 Set the effect channel selector to CH2.

- The parameter LED 2 lights up.
- The time of 1 beat (mSec.) of the BPM of the song input to CH2 is displayed on the auto BPM counter window (upper window).
- Select the BPM display (real-time/average) with the switch button.

Real-time display : Displays the measured BPM value for every beat.

If it cannot be measured for more than 5 seconds, " - - - " will be displayed.

Average display : Measures and displays the average of the BPM values measured every beat. Continues displaying the previous BPM value when the average value could not be measured.

3 Set the parameter value with the parameter knob (delay time).

- When the parameter value (delay time) is set according to the time of 1 beat of the BPM displayed on the auto BPM counter window (upper window), higher effects are produced.
- When 1/2 delay time is set to the time of 1 beat of the measured BPM, the beat display 1/2 LED lights up. Set the parameter value while referring to the beat display LED.
- * When the BPM cannot be measured, the beat display 1/2 to 4/1 LEDs will not light up.
- To check the effect sound, press the effect of the monitor selector. This will enable the effect sound to be monitored using the headphone output.

4 Turn on the effect switch.

- The effect switch blinks and the effect (delay) is imposed on the master output. Each press will turn on or off the effects.
- By turning on the effects according to the beat, the effects' cycle will be synchronized with the beat to produce better effects.

The echo, auto pan, and flanger effects can be produced by operating in the same way.

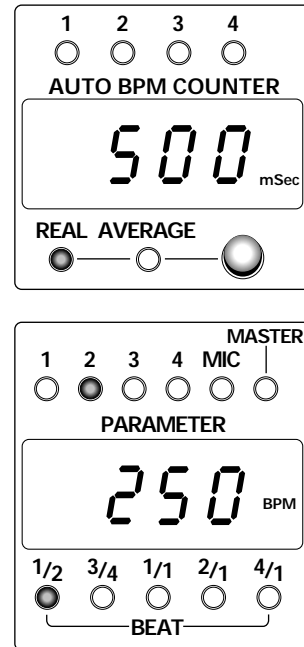

Display where a half beat delay (250 mSec) has been set to the music with BPM of 120 (time conversion 500 mSec.)

Precautions for Effect Function

- When an effect function (delay, echo, reverb, etc.) is on and is switched using the effect channel selector, the remaining effects of the channel before switching will be output completely.
- Use the effect selector while the effects are off (while the effect switch is lit). If used while the effects are on (while the effect switch is blinking), noises may be produced.

USING THE EFFECT FUNCTION

Operating Pitch Shifter and Reverb

(Example) Pitch-shift the CH3 song by 90%.

- 1 Set the effect selector to PITCH SHIFTER.
- 2 Set the effect channel selector to CH3.
 - The parameter LED 3 lights up.
 - * All the auto BPM counter displays go off.
- 3 Set the parameter value (pitch %) using the parameter knob.
 - To check the effect sound, press the effect of the monitor selector. This will enable the effect sound to be monitored using the headphone and booth monitor outputs.
- 4 Turn on the effect switch.
 - The effect switch blinks and the effect (pitch shift) is imposed on the master output. Each press will turn on or off the effects.

The reverb effects can be produced by operating in the same way.

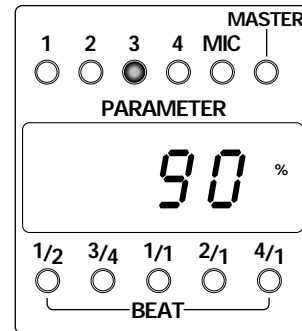
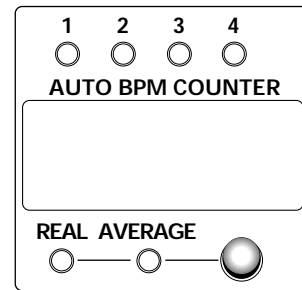

Display where CH3 has been pitch-shifted by 90%.

Using the External Effector

(Example) Set the external effect for the CH3 song.

- 1 Set the effect selector to SEND/RETURN.
- 2 Set the effect channel selector to CH3.
 - The parameter LED 3 lights up.
- 3 Set the parameter of the external effector, etc.
 - To check the effect sound, press the effect of the monitor selector. This will enable the effect sound to be monitored using the headphone and booth monitor outputs.
- 4 Turn on the effect switch.
 - The effect switch blinks and the effect (external effect) is imposed on the master output. Each press will turn on or off the effects.

To use the auto BPM counter while using the external effector, select one channel from CH1 to CH4 of the monitor selector (auto BPM counter selector).

- The LED of the channel selected by the auto BPM counter lights up.
- The BPM of the song input to the channel will be displayed on the auto BPM counter window (upper window).
- Select the BPM display (real-time/average) with the switch button.

Real-time display : Displays the measured BPM value for every beat.

If it cannot be measured for more than 5 seconds, " - - - " will be displayed.

Average display : Measures and displays the average of the BPM values measured every beat. Continues displaying the previous BPM value when the average value could not be measured.

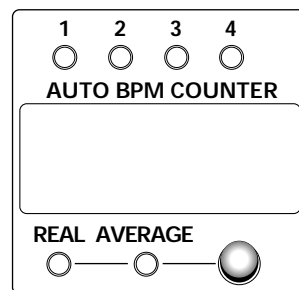

Displays the channel and BPM selected with the monitor selector.

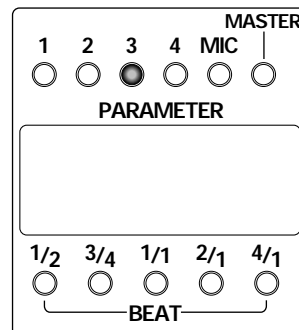

USING THE FADER START FUNCTION

By connecting the optional CD players CDJ-500G and CDJ-500II to CH1 and CH2, the player can be started using the channel fader or cross fader controls. (The control cable must be connected.)

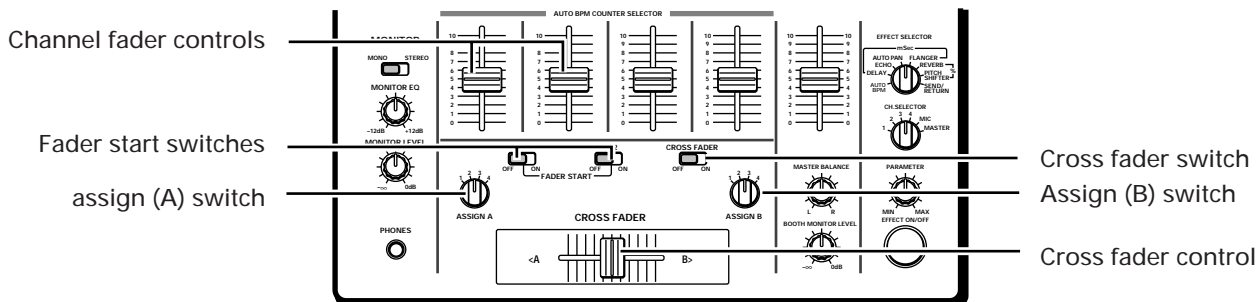

Fader Start Play

When the DJ mixer DJM-500 and the CD player CDJ-500G for DJs are connected using the control cable, fader start play can be performed. This means that by increasing the mixer fader control, the pause of the player will be released and the song starts immediately automatically. The cross fader can also be used to perform fader start play. By returning the fader to the original position, as the player will be returned to the cue point (back cue), sampler playing can also be performed. (DJM-500 fader start play can be performed even when combined with the CDJ-500G and CDJ-500II. However, back cue play can be performed only when combined with the CDJ-500II.)

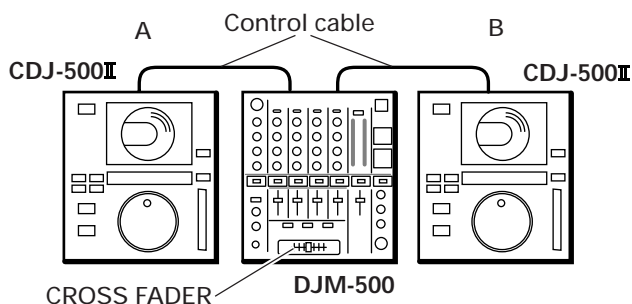

Cross Fader Start Play and Back Cue Play

A can be started just by moving the cross fader control from right to left during standby when A is at the cue point. Likewise, B can also be started just by moving the cross fader control from left to right during standby when B is at the cue point. At the same time, A will back cue (returns to the cue point).

Starting the Cross Fader

- 1 Turn on the cross fader switch.
- 2 Turn on the fader start switch (CH-1 or CH-2) of the channel connected to the player to be controlled.
- 3 Select the channel connecting the player with the assign switch.
- 4 Minimize the cross fader of the selected channel fully. (The example is the case of connecting the player to CH-1.)

[Example]

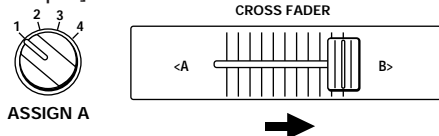

- 5 Set the cue point of the player and set the player to standby at this cue point.
- 6 To start playing, raise the cross fader volume at the timing to be started.

* This function will not work when assigns A and B are the same CH, etc.

Starting the Channel fader

- 1 Turn off the cross fader switch.
- 2 Turn on the fader start switch of the channel connected to the player to be controlled.
- 3 Minimize the channel fader controls fully.
- 4 Set the cue point of the player and set the player to standby at this cue point.
- 5 To start playing, raise the cross fader volume at the timing to be started.

The cue point may be preset in the CDJ-500II. In this case, there is no need for the player to standby at the cue point.

After playing starts, if the fader control is completely returned to the original position, the player will return to the cue point and set into the standby state.

TROUBLESHOOTING

Incorrect operations are often mistaken for trouble and malfunctions. If you think that there is something wrong with this component, check the points below. Sometimes the trouble may lie in another component. Investigate the other components and electrical appliances being used.

If the trouble cannot be rectified even after exercising the checks listed below, ask your nearest PIONEER authorized service center or your dealer to carry out repair work.

Symptom	Cause	Remedy
The power does not turn on.	<ul style="list-style-type: none"> The power cord is not connected. 	<ul style="list-style-type: none"> Connect to the power outlet.
No sound or soft sound.	<ul style="list-style-type: none"> The position of the input selector switch is wrong. The connection cord is not connected properly or disconnected. The terminal or plug is dirty. The master output level adjustment control is set too low. 	<ul style="list-style-type: none"> Select the device currently playing with the input selector switch. Connect properly. Clean and connect. Adjust the master output level adjustment control.
Noises	<ul style="list-style-type: none"> The master output level is too high. The input level is too high. 	<ul style="list-style-type: none"> Adjust with the master output level adjustment control. Adjust with the trim knob.
No cross fader.	<ul style="list-style-type: none"> The cross fader switch is OFF. The Assign A and B switches are not set correctly. 	<ul style="list-style-type: none"> Turn on the cross fader switch. Set the cross-fader source with the assign switch.
The fader of the CD player does not start.	<ul style="list-style-type: none"> The fader start switch is off. The player control terminal at the rear is not connected. 	<ul style="list-style-type: none"> Turn on the fader start switch. Connect the control terminals of the CD player and the unit with the control cord.
No effects.	<ul style="list-style-type: none"> The effect channel selector is not set correctly. The parameter knob is set to minimum (MIN). 	<ul style="list-style-type: none"> Select the channel to be imposed with the effects properly. Adjust the parameter knob.
External effector noise.	<ul style="list-style-type: none"> The level of the input from the external effector is too high. 	<ul style="list-style-type: none"> Lower the output level of the external effector.

Abnormal functioning of this unit may be caused by static electricity, or other external interference. To restore normal operation, turn the power off and then on again.

Replacement of Cross Fader Volume Control

The unit has a structure which allows its cross fader to be replaced.

Replace as follows.

- Disconnect the power plug of the unit from the outlet.
- Pull up the knob (A) of the cross fader and remove.
- Remove the two screws (B) and remove the slider panel (C).
- Remove the cross fader assembly from the unit, and disconnect the connector (D).
- Remove the two screws (E) and replace the cross fader volume control with a new one.
- Attach the screws (E), connector (D), slider panel (C), screws (B), and knob (A) of the cross fader in the reverse order of the above.

Fully insert the connector (D) into the cross fader assembly. If it is not fully inserted, the unit will not work correctly.

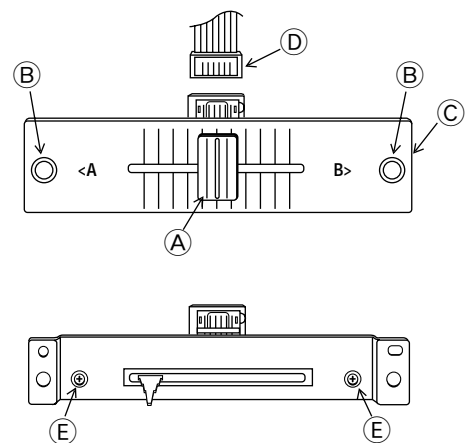

NOTES:

- Do not touch the internal parts of the unit or put your hand inside the unit, as this may cause injuries and damage to the unit.
- Be careful not to drop removed parts and screws inside the unit.

Order the cross fader assembly (DWG1473) from your nearest dealer or PIONEER authorized service center.

SPECIFICATIONS

Audio Section

Input terminal (Input level/impedance)

CD/LINE	-14 dBV (200 mV) / 22 k Ω
PHONO	-54 dBV (2 mV) / 47 k Ω
MAIN MIC	-54 dBV (2 mV) / 3 k Ω
SUB MIC	-60 dBV (1 mV) / 3 k Ω
RETURN	-14 dBV (200 mV) / 22 k Ω

Output terminal (Output level/impedance)

MASTER OUT 1 (RCA)	0 dBV (1 V) / 1 k Ω
MASTER OUT 2 (XLR)	4 dBm (1.23 V) / 600 Ω
MASTER OUT 3 (1/4"PHONE)	0 dBV (1 V) / 1 k Ω
BOOTH MONITOR	0 dBV (1 V) / 1 k Ω
SEND	0 dBV (1 V) / 1 k Ω
PHONES	-4 dBV (0.63 V) / 22 Ω

Frequency characteristics

CD/LINE	20 Hz to 20 kHz (± 0.5 dB)
PHONO	20 Hz to 20 kHz (± 1.5 dB/RIAA)
MIC	20 Hz to 20 kHz (± 2 dB)

SN ratio

CD/LINE	85 dB
PHONO	77 dB
MIC	69 dB

Total harmonic distortion rate

CD/LINE ,PHONO ,MIC	Below 0.02 %
---------------------------	--------------

Cross talk..... 70 dB

Channel equalizer

LOW	+12 dB, -20 dB (100 Hz)
MID	+12 dB, -20 dB (1 kHz)
HI	+12 dB, -20 dB (10 kHz)

Microphone equalizer

LOW	± 12 dB (100 Hz)
MID	± 12 dB (1 kHz)
HI	± 12 dB (10 kHz)

Monitor equalizer ± 12 dB (100 Hz)

Effector

Delay, echo	0 to 680 mSec
Auto pan	0 to 3500 mSec
Flanger	100 to 9000 mSec
Reverb	0 to 100 %
Pitch shifter	0 to ± 100 %

Electrical Section, Others

Power supply voltage	AC 120 V, 60 Hz
Power consumption	41 W
Operating temperature	+5 $^{\circ}$ C to +35 $^{\circ}$ C
Operating humidity	5 % to 85 %
External dimensions	320 (W) \times 357.4 (D) \times 107 (H) mm 12-5/8 (W) \times 14-1/16 (D) \times 4-3/16 (H) in
Weight	5.9 kg (13 lb)

Accessories

- Power cord 1
- Short-circuit pin plug 4
- Operating instructions 1

NOTE:

Specifications and the design are subject to possible modifications without notice, due to improvements.

Published by Pioneer Electronic Corporation.
Copyright © 1995 Pioneer Electronic Corporation.
All rights reserved.

PIONEER ELECTRONIC CORPORATION 4-1, Meguro 1-Chome, Meguro-ku, Tokyo 153, Japan
PIONEER NEW MEDIA TECHNOLOGIES, INC. 2265 East 220th Street, Long Beach, California 90810, U.S.A.
PIONEER ELECTRONICS OF CANADA, INC. 300 Allstate Parkway, Markham, Ontario L3R 0P2, Canada